

Grizzly *Industrial, Inc.*®

MODEL H8230/H8231

15° COIL NAILER

OWNER'S MANUAL



COPYRIGHT © SEPTEMBER, 2007 BY GRIZZLY INDUSTRIAL, INC. REVISED JULY, 2008 (JM)

WARNING: NO PORTION OF THIS MANUAL MAY BE REPRODUCED IN ANY SHAPE OR FORM WITHOUT THE WRITTEN APPROVAL OF GRIZZLY INDUSTRIAL, INC.

#LOTR9634 PRINTED IN CHINA

SAFETY

WARNING

For Your Own Safety Read Instruction Manual Before Operating This Equipment

The purpose of safety symbols is to attract your attention to possible hazardous conditions. This manual uses a series of symbols and signal words which are intended to convey the level of importance of the safety messages. The progression of symbols is described below. Remember that safety messages by themselves do not eliminate danger and are not a substitute for proper accident prevention measures.



Indicates an imminently hazardous situation which, if not avoided, **WILL** result in death or serious injury.



Indicates a potentially hazardous situation which, if not avoided, **COULD** result in death or serious injury.



Indicates a potentially hazardous situation which, if not avoided, **MAY** result in minor or moderate injury. It may also be used to alert against unsafe practices.

NOTICE

This symbol is used to alert the user to useful information about proper operation of the equipment.

WARNING

Safety Instructions For Pneumatic Tools

1. **KEEP ALL SAFETY DEVICES IN PLACE** and in working order.
2. **REMOVE ADJUSTING KEYS AND WRENCHES.** Form habit of checking to see that keys and adjusting wrenches are removed from tool before operation.
3. **KEEP WORK AREA CLEAN.** Cluttered areas and benches invite accidents.
4. **DO NOT USE IN DANGEROUS ENVIRONMENT.** Do not use pneumatic tools in damp or wet locations, or where any flammable or noxious fumes may exist. Keep work area well lighted.
5. **KEEP CHILDREN AND VISITORS AWAY.** All children and visitors should be kept at a safe distance from work area.
6. **MAKE WORKSHOP CHILD PROOF** by locking your shop and shutting off air valves.
7. **DO NOT FORCE TOOL.** It will do the job better and safer at the rate for which it was designed.
8. **USE THE RIGHT TOOL.** Do not force tool or attachment to do a job for which it was not designed.
9. **DO NOT USE UNDER THE INFLUENCE OF DRUGS OR ALCOHOL.**

WARNING

Safety Instructions For Pneumatic Tools

10. **USE PROPER AIR HOSE** for the tool. Make sure your air hose is in good condition and is long enough to reach your work without stretching.
11. **WEAR PROPER APPAREL.** Do not wear loose clothing, gloves, neckties, rings, bracelets, or other jewelry which may get caught in moving parts. Non-slip footwear is recommended. Wear a protective hair covering to contain long hair.
12. **ALWAYS USE SAFETY GLASSES.** Also use a face or dust mask if cutting operation is dusty. Everyday eyeglasses only have impact resistant lenses, they are NOT safety glasses.
13. **WEAR APPROVED HEARING PROTECTION.** Air escaping from pneumatic tools can exceed safe exposure limits and may cause hearing damage with prolonged exposure.
14. **SECURE WORK.** Use clamps or a vise to hold work when practical. It is safer than using your hand and frees both hands to operate tool.
15. **MAINTAIN TOOLS WITH CARE.** Keep tools lubricated and clean for best and safest performance. Follow instructions for lubricating and changing accessories.
16. **REDUCE THE RISK OF UNINTENTIONAL FIRING.** Do not carry tool with hand on trigger and always disconnect from air when not in use.
17. **DISCONNECT TOOLS** before servicing, changing accessories, or moving to another location.
18. **DO NOT OVERREACH.** Keep proper footing/balance at all times.
19. **USE THE RECOMMENDED ACCESSORIES.** Consult owner's manual for recommended accessories. The use of improper accessories may cause risk of injury.
20. **CHECK FOR DAMAGED PARTS BEFORE USING.** Check for binding and alignment of parts, broken parts, part mounting, loose bolts, and any other conditions that may affect machine operation. Repair or replace damaged parts.
21. **NEVER LEAVE UNATTENDED TOOL CONNECTED TO AIR.** Disconnect the air hose and do not leave tool until it is relieved of any built up pressure.
22. **NEVER ALLOW UNTRAINED USERS TO USE THIS TOOL WHILE UNSUPERVISED.**
23. **IF YOU ARE UNSURE OF THE INTENDED OPERATION, STOP USING TOOL.** Seek formal training or research books or magazines that specialize in pneumatic tools.
24. **BE AWARE OF HOSE LOCATION WHEN USING PNEUMATIC TOOLS.** Hoses can easily become a tripping hazard when laid across the floor or spread out in a disorganized fashion.

⚠️ WARNING

Additional Safety Instructions for Nailers

- HAND INJURIES:** Do not place your hands near the nail point of entry. A nail can deflect and tear through the surface of the workpiece, puncturing your hand or fingers.
- COMBUSTIBLE GASES:** Never connect the nailer to pressurized oxygen or other combustible gases as a power source. Only use filtered, lubricated, and regulated compressed air.
- SAFE HANDLING:** Never point the nailer at others! Do not keep the trigger pulled when loading fasteners, carrying, or holding tool. Carry the nailer only by the handle, never by any other part. Do not carry the nailer by the air hose. Disconnect the nailer from the air hose when going up and down ladders.
- CLEANING:** Never use gasoline or other flammable liquids to clean the nailer; vapors in the nailer will ignite by a spark and cause it to explode.
- HOSE USAGE:** Make sure your air hose is designed for the tool in use, is in good condition, and is long enough to reach your work without stretching. However, an overly long air hose in the work area may be a tripping hazard.
- OPERATING QUESTIONS:** If you are not sure about the intended operation, stop using the nailer. Seek formal training or research books or magazines that specialize in pneumatic tools.
- MAINTENANCE:** Always disconnect air from the nailer when servicing or installing nails. During maintenance, a nailer connected to air may fire accidentally, causing serious personal injury.
- COMPRESSED AIR RATING:** Do not connect the nailer to compressed air that exceeds 120 PSI.
- CHECK VALVE:** Do not use a check valve or any other fitting that allows air to remain in the tool.

⚠️ WARNING



Read this entire manual before operation. Serious personal injury may result if safety or operational information is not understood or followed.

INTRODUCTION

Foreword

The specifications, details, and photographs in this manual represent the Model H8230/H8231 as supplied when the manual was prepared. However, owing to Grizzly's policy of continuous improvement, changes may be made at any time with no obligation on the part of Grizzly.

If you have any comments regarding this manual, please contact us:

Grizzly Industrial, Inc.
C/O Technical Documentation Manager
P.O. Box 2069
Bellingham, WA 98227-2069
Email: manuals@grizzly.com

Most importantly, we stand behind our tools. If you have any service questions or parts requests, please call or write us at the location listed below.

Grizzly Industrial, Inc.
1203 Lycoming Mall Circle
Muncy, PA 17756
Phone: (570) 546-9663
Fax: (800) 438-5901
E-Mail: techsupport@grizzly.com
Web Site: <http://www.grizzly.com>

Machine Data

Model H8230

Nail Type Flat Wire Welded Coil
Nail Angle 15°
Nail Length $\frac{3}{4}$ "–1 $\frac{3}{4}$ "
Nail Diameter..... 0.091"–0.120"
Magazine Capacity 120 Nails
Air Inlet $\frac{1}{4}$ " NPT
Weight 6.05 lbs.
Operating Pressure 70–110 PSI
Maximum Permissible Pressure 120 PSI

Model H8231

Nail Type Flat Wire Welded Coil
Nail Angle 15°
Nail Length 1 $\frac{3}{4}$ "–2 $\frac{3}{4}$ "
Nail Diameter..... 0.091"–0.120"
Magazine Capacity 225–300 Nails
Air Inlet $\frac{1}{4}$ " NPT
Weight 7.7 lbs.
Operating Pressure 70–110 PSI
Maximum Permissible Pressure 120 PSI

SET UP

Unpacking

Your nailer was carefully packaged for safe shipping. If you discover any damage after you have signed for delivery, *immediately call Customer Service at (570) 546-9663 for advice.*

Save the containers and all packing materials for possible inspection by the carrier or its agent. *Otherwise, filing a freight claim can be difficult.*

When you are completely satisfied with the condition of the shipment, you should inventory the contents.

Inventory

Model H8230/H8231 Inventory (Figure 1)

- A. Coil Nailer 1
- B. Case..... 1
- C. Pneumatic Tool Oil 1
- D. Safety Goggles 1
- E. Hex Wrenches 3, 4, 5, 6mm..... 1 Each



Figure 1. Model H8230/H8231 inventory (H8230 shown).

Compressed Air System

The Model H8230/H8231 is designed to operate at 70-110 PSI using clean, dry, regulated, compressed air. **DO NOT exceed the 120 PSI maximum operating pressure for your model.**

An in-line filter/lubricator/regulator unit, depicted in **Figure 2**, can be installed and should be located as close to the nailer as possible.

This filter/lubricator/regulator unit will protect your tool from damaging water build-up, allow you to adjust and maintain constant air pressure to your tool, and save you the inconvenience of having to manually lubricate your tool every time you use it.

⚠ WARNING

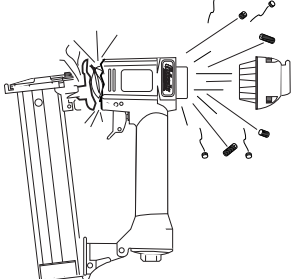

Exceeding the maximum permissible operating pressure may cause the nailer to explode, blowing metal fragments in all directions. To protect yourself from serious personal injury, DO NOT allow your air compressor to exceed the recommended pressure when connected to this nailer!

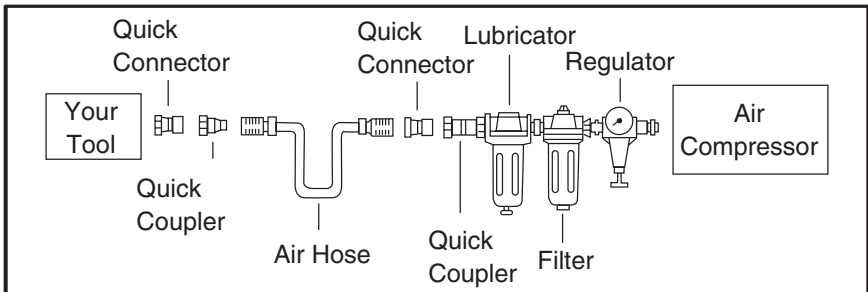

Figure 2. Typical filter/lubricator/regulator installation order.

Safety Check

A safety mechanism on the nose of the nailer protects against accidental firing. The nailer is designed to only fire when the safety nose is depressed and the trigger is pulled. The nailer should not fire otherwise.

This nailer also features a trigger lock switch as an additional way to prevent accidental firing.

Before you use your nailer for the first time, you **MUST** verify that the safety mechanisms on the nailer are working properly; otherwise, the risk of accidental injury will be greatly increased.

The nailer must be connected to a properly regulated air source to perform these safety checks.

Safety Check #1—Nose

Without pulling the trigger, depress the safety nose mechanism against a scrap piece of wood that is clean and free of any knots, nails, or other foreign objects.

- If the nailer **does not fire**, then the safety nose mechanism is working correctly.
- If the nailer **does fire** when you do this, immediately disconnect the nailer from the air supply and call Grizzly Technical Support at (570) 546-9663 for help.

Safety Check #2—Trigger

Make sure the nose is not depressed, point the nailer in a safe direction away from yourself or bystanders, then pull the trigger.

- If the nailer **does not fire**, then the trigger mechanism is working correctly.
- If the nailer **does fire** when you do this, immediately disconnect the nailer from the air supply and call Grizzly Technical Support at (570) 546-9663 for help.

Safety Check #3—Trigger Lock

Rotate the trigger lock switch counter-clockwise so the arrow points to the lock icon on the nailer body. Make sure the nose is not depressed, point the nailer in a safe direction away from yourself or bystanders, then try to pull the trigger.

- If the trigger is locked and the nailer **does not fire**, then the trigger lock is working correctly.
- If the nailer **does fire** when you do this, immediately disconnect the nailer from the air supply and call Grizzly Technical Support at (570) 546-9663 for help.

WARNING

The safety mechanisms are not fool-proof. Never rely on these mechanisms as an excuse to point the nailer at yourself or any bystanders. Serious injury may occur.

OPERATIONS

Loading

When replacing nails in your Model H8230/H8231, follow these guidelines:

Nail Type:	Flat Wire Welded Coil 15° Nail
Length:	H8230 3/4"–1 3/4" H8231 1 3/4"–2 3/4"
Capacity:	H8230 120 Nails H8231 225–300 Nails

To load your nailer:

1. DISCONNECT NAILER FROM THE AIR SUPPLY!
2. Squeeze the latch shown in **Figure 3**, then open the feeder cover and magazine, as shown in **Figure 4**.

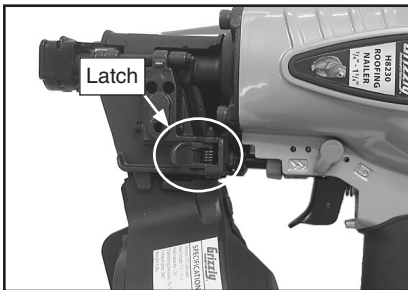

Figure 3. Feeder cover latch.



Figure 4. Feeder cover & magazine open.

3. Pull up and rotate the adjusting plate, shown in **Figure 5**, to match the magazine mark with the nail length to be installed. (Rotating the adjusting plate locks or unlocks its position.)

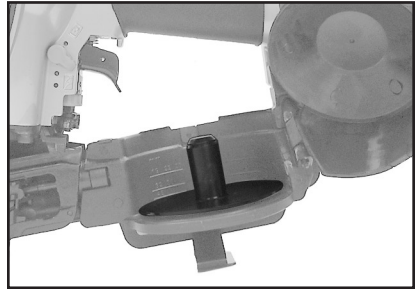

Figure 5. Adjusting plate.

4. Place the nails over the adjusting plate post, and put the first nail into the feeder pawls as shown in **Figure 6**.

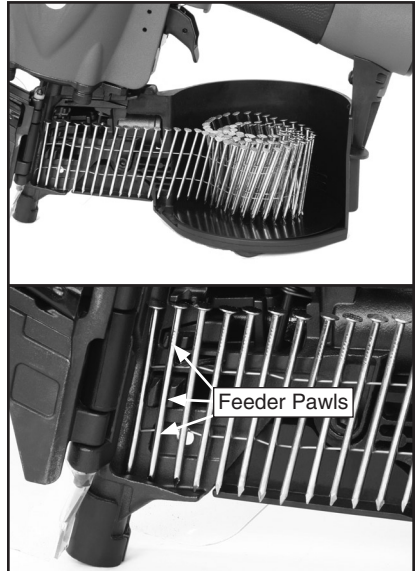

Figure 6. Loading nails in the magazine.

5. Close the magazine cover, then close the drive hole and feeder cover and latch it closed.

Firing Nails

If you have not read the safety instructions in this manual, do not operate the nailer.

Before you operate your nailer, place five to six drops of the included oil into the quick connect fitting where the nailer connects to the air supply, unless your air system uses a lubricator as described on **Page 5**.

While operating your nailer, keep in mind that nail deflection is a constant hazard. Deflection is caused when grain irregularities, knots or foreign objects inside the wood cause the nail to change its path, resulting in the nail puncturing the surface of the workpiece, as shown in **Figure 7**.

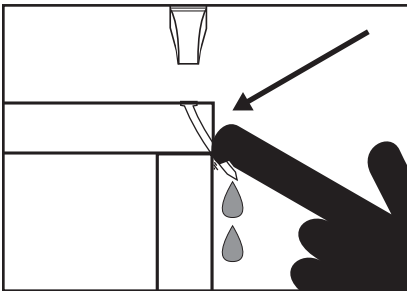

Figure 7. Example of nail deflection.

Besides damaging your workpiece, deflection can cause injury if your free hand is securing the workpiece in the location that the nail deflects.

To reduce your risk of injury from nail deflection, always make sure your free hand and other body parts are positioned out of the way of a potential path of a nail before pulling the trigger.

⚠ WARNING

During operation, this nailer can propel objects into the air and exhaust concentrated bursts of air, causing immediate eye damage. To reduce your risk from these hazards, always wear ANSI approved safety glasses or a face shield.

In addition, this nailer discharges at up to 85-90 decibels. To reduce your risk of hearing loss from operating this nailer, always wear ANSI approved ear protection.

⚠ WARNING

Never point this nailer at yourself or another person! Always pay attention to the direction this nailer is pointed to reduce the risk of serious injury.

To fire a nail:

1. Connect the nailer to your air supply.
2. Depress the safety nose mechanism flat against the work surface, and pull the trigger.
3. Check the nail penetration depth.
 - If the nail either went too far or not far enough, then refer to **Adjusting Depth** on **Page 9**.

Adjusting Depth

The Model H8230/H8231 features a depth adjustment knob for controlling nail penetration depth (**Figures 8 & 9**).

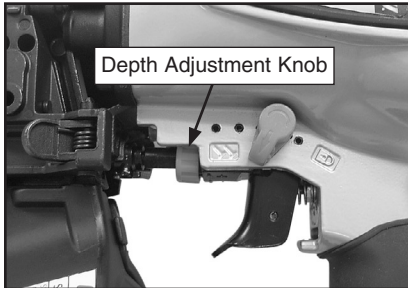

Figure 8. H8230 depth adjustment knob.

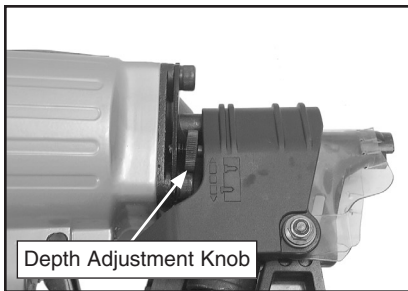

Figure 9. H8231 depth adjustment knob.

The adjustment knob controls nail penetration by changing where the nose mechanism stops when depressed. Moving the nose mechanism out or extending it away from the nailer decreases nail penetration depth.

Determining the correct nail penetration depth requires trial-and-error and may change depending on the type of material you are nailing.

Single/Bump Fire Operation

The nailer is designed to fire one nail at a time, or one after another, using the safety nose mechanism—this is known as "bump fire."

To operate your nailer in single fire mode:

1. Depress the safety nose mechanism against the workpiece.
2. Pull the trigger, then release the trigger after the nail is driven.

To operate your nailer in bump fire mode:

1. Pull the trigger and hold it back.
2. Press the safety nose mechanism against your workpiece to fire a nail. You can continue holding the trigger back and firing the nailer in this manner without releasing the trigger.

⚠️ WARNING

Take care to lift the nailer from the workpiece each time you fire a nail when bump firing, or the nailer may bounce across the workpiece and rapidly fire nails.

Replacing Pistons/O-Rings

If you use your nailer on a daily basis, replacement pistons are cheap insurance against wasted down time and lost profits in the event that a piston or piston shaft wears out.



To replace a piston:

1. DISCONNECT NAILER FROM THE AIR SUPPLY!
2. Remove all nails from the magazine cartridge.
3. Remove the four cap screws on the back of the nailer, near the exhaust port.
4. Remove the cap.
5. The top of the piston should now be visible inside the cylinder, which is housed in the head of the nailer.

6. Open the nose cover as if to clear a jammed nail.
7. Watch the discharge area and push the top of the piston with your finger. You will see the piston shaft slide down the discharge area.
8. With a long wood dowel or similarly shaped tool, push the piston shaft back inside the nailer until you can grip the piston head and remove it from the cylinder. (If using metal tools, be careful not to scratch the discharge area or cylinder when removing the piston shaft.)
9. Place a new O-ring on the new piston and apply a thin film of the air tool oil on the O-ring.
10. Insert the new piston in the cylinder. Make sure that any grooves on the piston shaft line up with those on the guide at the bottom of the cylinder. The new piston should easily slide into the cylinder. **DO NOT force the piston into the cylinder!** If the piston is not easily inserted, double-check the alignment of the piston shaft with grooves on the guide.
11. After the piston is inserted correctly, close the magazine. Replace the rear cap assembly and tighten the four cap screws.
12. For more assistance, or to install a complete O-ring set, refer to the appropriate breakdown diagram in the back of this manual for component locations.

ACCESSORIES

Replacement 15° Coil Nails

H9670—1½" Long, 0.099"Ø, 12,000 pcs

H9671—1¾" Long, 0.099"Ø, 9,000 pcs

H9672—2" Long, 0.091"Ø, 9,000 pcs

H9673—2" Long, 0.099"Ø, 9,000 pcs

H9674—2½" Long, 0.099"Ø, 9,000 pcs

G8114—¾" x 25 Ft. Air Hose

G8115—¾" x 50 Ft. Air Hose

G8116—¾" x 100 Ft. Air Hose

Multi-purpose red rubber air hose is flexible and abrasion resistant. Rated for 200 PSI, this air hose has a bursting strength of 800 PSI. ¼" NPT ends.



Figure 10. Red rubber air hose.

H3275—¼" x 25' Recoil Air Hose

H3276—¼" x 50' Recoil Air Hose

These recoil air hoses are ideal for nailers and staplers because they are light weight and offer maneuverability in tight places that is unmatched by rubber hoses. Coiled springs protect the ends from kinking. (Prices are less than you'll spend on lunch!)

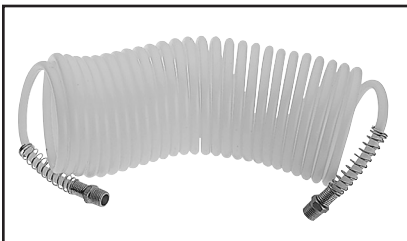

Figure 11. Recoil air hose.

H3175—¼" NPT Female, Quick Coupler

H3176—¼" NPT Male, Quick Coupler

H3177—¼" NPT Male, Plug

H3178—¼" NPT Female, Plug

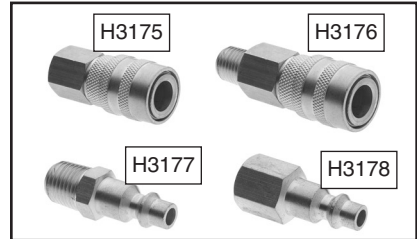

Figure 12. ¼" NPT air fittings.

H3258—Filter/Lube/Regulator ¾"NPT

H3259—Filter/Lube/Regulator ½"NPT

These units are indispensable for prolonging the lifespan of your air tools. Filter keeps water/rust out. Lubricator features adjustable automatic lubrication. Regulator allows you to control the optimum PSI delivery for each air tool. Maximum pressure for each unit is 150 PSI.



Figure 13. Models H3258 & H3259 Filter/Lubricator/Regulators.

G2820—Pneumatic Tool Oil 8 oz.

G2821—Pneumatic Tool Oil 1 Pint

Use the right oil! This pneumatic tool oil offers outstanding heat displacement and friction reduction without eating away at delicate air components like detergent motor oils. Stock up with extra bottles to avoid costly downtime.

CLEANING & LUBRICATION

Cleaning

Use a good solvent to clean the nose assembly of the nailer. Always be sure that the nailer is dry before using it again.

Do not allow dust, chips, sand, etc. into the air connectors or into the body of the nailer; this may result in leaks and damage to the nailer and the air couplings.

⚠ WARNING



Never use gasoline or other flammable liquids to clean this tool. Vapors in the tool may ignite, causing the tool to explode. Ignoring this warning may lead to serious personal injury or even death!

Lubricating

Special oil has been included with your new Grizzly nailer to help maintain its useful life. Place two to six drops of oil in the nailer air inlet (as shown in **Figure 14**) before every use, or after 2 hours of continuous use.

Wipe off any excess oil near the nailer exhaust to avoid dust build-up. When the oil that was included with the nailer has been completely used, replace with Grizzly Model G2820 Pneumatic Tool Oil.

Another option to manual oiling would be to install a lubricator in your air compressor line. If your air compressor line already has a lubricator, then regular lubrication of your nailer will not be necessary. Just make sure there is always oil in the lubricator.

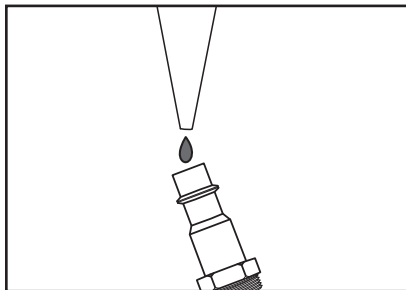

Figure 14. Lubricating nailer via air inlet.

TROUBLESHOOTING

Symptom	Possible Cause	Solution
Air leaking at trigger valve area.	1. O-rings in trigger valve housing are damaged.	1. O-rings must be replaced & operation of safety nose must be checked.
Air leaking between housing and hose.	1. Loose screws in housing. 2. Damaged O-ring. 3. Loose air fitting.	1. Tighten screws. 2. Replace O-ring. 3. Tighten air fitting & use teflon tape.
Air leaking between housing and cap assembly.	1. Damaged seal.	1. Replace damaged seals.
Tool skips nails while discharging.	1. Air leaks. 2. Dirt in nose. 3. Dirt or damage prevents nails from moving freely in magazine. 4. Inadequate air flow to tool. 5. Worn O-ring on piston or lack of lubrication. 6. Damaged O-rings on trigger valve. 7. Worn bumper. 8. Cap seal leaking.	1. Tighten screws and fittings. 2. Clean nose. 3. Clean magazine and inspect/repair damage. 4. Check fitting, hose, compressor & air pressure. 5. Replace piston O-ring. Lubricate. 6. Replace trigger valve O-rings. 7. Replace bumper. 8. Replace cap seal.
Tool runs slowly or has a loss of power.	1. Nailer is not sufficiently lubricated. 2. Broken spring in cap assembly. 3. Exhaust port in cap is blocked.	1. Lubricate nailer. 2. Replace spring. 3. Clean or replace damaged internal parts.
Fasteners frequently jam the nailer.	1. Nails are the wrong size. 2. Nails are bent or dirty. 3. Magazine or nose screws are loose. 4. Driver or driver guide are worn or damaged. 5. Nails are wrong angle.	1. Use correct nails. 2. Use undamaged, clean nails. 3. Tighten magazine. 4. Replace worn or damaged parts. 5. Use correct angle nails.
Nailer does not fire.	1. Nail is jammed in magazine or discharge area. 2. Piston shaft is damaged. 3. Air pressure too low.	1. Clear nailer magazine or discharge area. 2. Replace piston shaft. 3. Check/increase air pressure.

H8230 PARTS LIST

REF PART #	DESCRIPTION
1	PH8230001 SPECIAL FLANGE BOLT
2	PH8230002 EXHAUST PORT
3	PH8230003 SPACER
4	PH8230004 PIN
5	PH8230005 COMPRESSION SPRING
6	PSB06M CAP SCREW M6-1 X 25
7	PH8230007 CYLINDER COVER
8	PH8230008 BUMPER
9	PH8230009 CLAPBOARD
10	PORP050 O-RING 49.7 X 3.5 P50
11	PORP018 O-RING 17.8 X 2.4 P18
12	PH8230012 COMPRESSION SPRING
13	PH8230013 VALVE
14	PORP049 O-RING 48.7 X 3.5 P49
15	PH8230015 VALVE SEAL
16	PORP040 O-RING 39.7 X 3.5 P40
17	PH8230017 PISTON ASSEMBLY
18	PH8230018 CYLINDER
19	PORG050 O-RING 49.4 X 3.1 G50
20	PH8230020 CYLINDER SEAL
21	PH8230021 COLLAR
22	PORG070 O-RING 69.4 X 3.1 G70
23	PH8230023 GASKET
24	PH8230024 GUN BODY
25	PH8230025 PROTECTION PLATE
26	PH8230026 BUMPER
27	PORS050 O-RING 49.5 X 2.0 S50
28	PH8230028 NAILER HEAD
29	PH8230029 SPECIAL NUT
30	PORP003 O-RING 2.8 X 1.9 P3
31	PH8230031 MAGNET
32	PH8230032 NAIL PAWL
33	PH8230033 COMPRESSION SPRING
34	PSB23M CAP SCREW M4-.7 X 12
35	PH8230035 PROTECTION COVER
36	PH8230036 NOSE SAFETY SLIDE
37	PH8230037 NOSE TIP
38	PH8230038 STEEL BLOCK
39	PEC07M E-CLIP 7MM
40	PH8230040 STEEL BALL
41	PH8230041 COMPRESSION SPRING
42	PH8230042 TRIGGER LOCK
43	PRP02M ROLL PIN 3 X 16
44	PH8230044 SAFETY PLATE
45	PH8230045 TRIGGER
46	PRP13M ROLL PIN 2.5 X 19
47	PH8230047 ADJUSTABLE SEAT
48	PRP13M ROLL PIN 2.5 X 19
49	PH8230049 COMPRESSION SPRING
50	PH8230050 GASKET
51	PH8230051 LEVER
52	PH8230052 ADJUSTABLE SCREW
53	PH8230053 NAIL DEPTH KNOB
54	PEC13M E-CLIP 5MM
55	PORP011-2 O-RING 11 X 2.4 P11.2

REF PART #	DESCRIPTION
56	PH8230056 VALVE SEAT
57	PORS011-2 O-RING 10.7 X 1.5 S11.2
58	PORS007 O-RING 6.5 X 1.5 S7
59	PH8230059 VALVE GUIDE
60	PH8230060 COMPRESSION SPRING
61	PH8230061 O-RING 1.9 X 1.1
62	PH8230062 SWITCH LEVER
63	PH8230063 O-RING 2 X 1.5
64	PORP015 O-RING 14.8 X 2.4 P15
65	PH8230065 SWITCH SEAT
66	PORP009 O-RING 8.8 X 1.9 P9
67	PH8230067 STEEL PIN
68	PH8230068 PISTON
69	PH8230069 RUBBER COLLAR 3.5 X 1 X 3
70	PORP016 O-RING 15.8 X 2.4 P16
71	PH8230071 SEALING WASHER
72	PH8230072 COMPRESSION SPRING
73	PH8230073 SPRING SEAT
74	PR66M INT RETAINING RING 25MM
75	PH8230075 STEEL PIN
76	PH8230076 TORSION SPRING
77	PH8230077 BLOCK
78	PH8230078 COMPRESSION SPRING
79	PH8230079 STEEL PIN
80	PH8230080 MOVABLE COVER
81	PH8230081 HANDLE
82	PH8230082 STAND BRACKET
83	PSB02M CAP SCREW M6-1 X 20
84	PH8230084 METAL MAGAZINE CLIP
85	PH8230085 MAGAZINE COVER
86	PH8230086 MAGAZINE POST NUT
87	PH8230087 EXTENSION SPRING
88	PH8230088 MAGAZINE
89	PH8230089 MAGAZINE HINGE PIN
90	PH8230090 NAIL ADJUSTING PLATE
91	PH8230091 SPRING HOOK
92	PFN04M FLANGE NUT M5-.8
93	PSB95M CAP SCREW M5-.8 X 30
94	PH8230094 RUBBER GRIP
95	PORP045 O-RING 44.7 X 3.5 P45
96	PH8230096 END PLATE
97	PH8230097 MALE AIR FITTING 1/4" NPT
98	PH8230098 AIR FITTING DUST PLUG
99	PAW06M HEX WRENCH 6MM
100	PAW05M HEX WRENCH 5MM
101	PAW04M HEX WRENCH 4MM
102	PAW03M HEX WRENCH 3MM
103	PH8230103 SAFETY GLASSES
104	PH8230104 O-RING REPAIR KIT
105	PH8230105 PISTON REPAIR KIT
106	PH8230106 CARRYING CASE
107	PH8230107 NAILER WARNING LABEL
108	PH8230108 H8230 DECORATIVE LABEL
109	PH8230109 MACHINE ID LABEL

H8231 PARTS BREAKDOWN

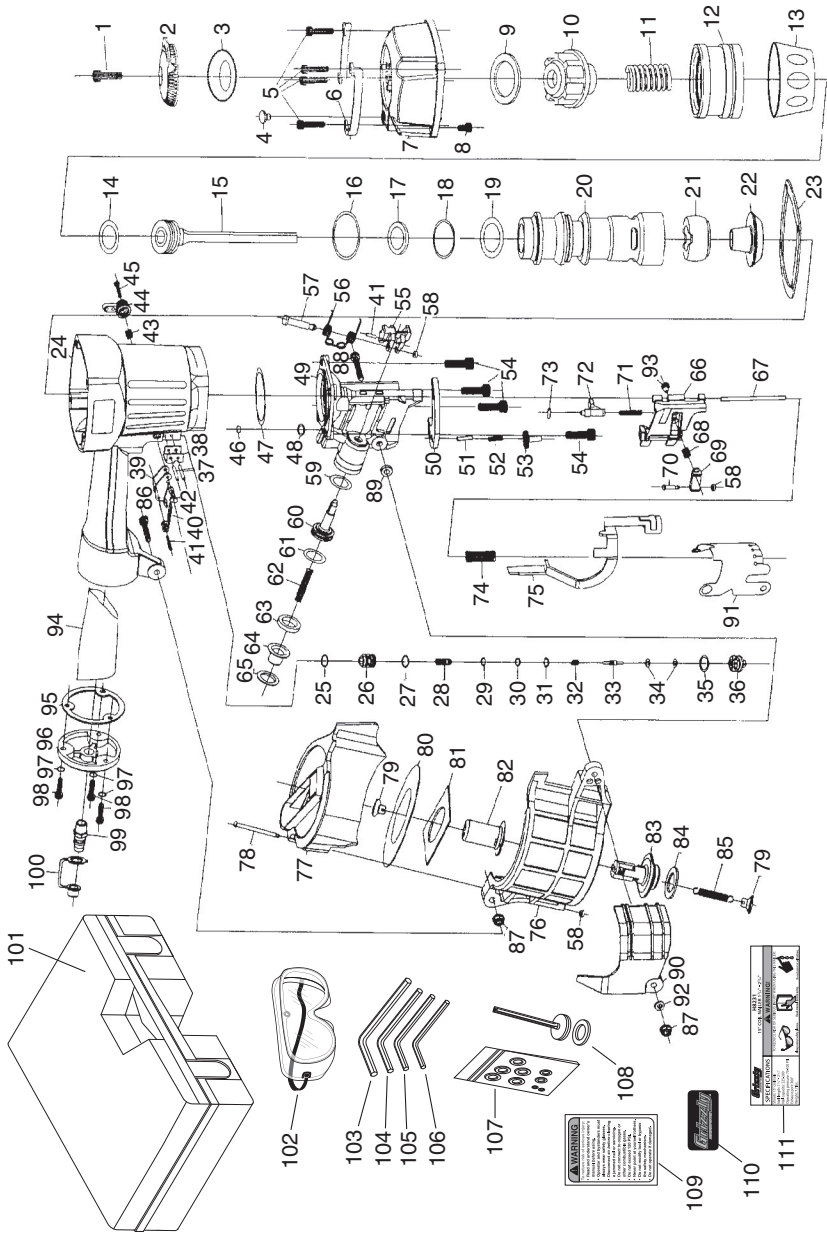

H8231 PARTS LIST

REF PART #	DESCRIPTION
1	PH8231001 SHOULDER BOLT M5-.8 X 8
2	PH8231002 AIR DEFLECTOR
3	PH8231003 SPRING PLATE
4	PH8231004 CYLINDER BOLT
5	PSB06M CAP SCREW M6-1 X 25
6	PH8231006 PROTECTION STAND
7	PH8231007 CYLINDER COVER
8	PH8231008 HEX BOLT M5-.8 X 6
9	PH8231009 SEALING WASHER
10	PH8231010 SPRING BASE
11	PH8231011 COMPRESSION SPRING
12	PH8231012 BALANCE VALVE ASSY
13	PH8231013 COLLAR
14	POR0079 O-RING 42.3 X 5
15	PH8231015 DRIVER BLADE
16	POR0080 O-RING 88 X 3
17	PH8231017 FIXED RING
18	PORP058 O-RING 57.6 X 5.7 P58
19	PORP056 O-RING 55.6 X 5.7 P56
20	PH8231020 CYLINDER
21	PH8231021 OUTSIDE BUMP WASHER
22	PH8231022 INSIDE BUMP WASHER
23	PH8231023 CYLINDER COVER SLICE
24	PH8231024 GUN BODY
25	PORP015 O-RING 14.8 X 2.4 P15
26	PH8231026 VALVE RING
27	PORS018 O-RING 17.5 X 1.5 S18
28	PH8231028 VALVE SLEEVE
29	POR0061 O-RING 6 X 1.8
30	PORP006 O-RING 5.8 X 1.9 P6
31	PORP009 O-RING 8.8 X 1.9 P9
32	PH8231032 TRIGGER SPRING
33	PH8231033 TRIGGER POLE
34	PORP020 O-RING 19.8 X 2.4 P20
35	PORS003 O-RING 2.5 X 1.5 S3
36	PH8231036 SWITCH KNOB
37	PRP16M ROLL PIN 3 X 25
38	PH8231038 SLIDING BASE
39	PH8231039 TRIGGER
40	PH8231040 SAFETY NOSE
41	PRP02M ROLL PIN 3 X 16
42	PH8231042 ADJUSTING PIN
43	PH8231043 SPRING
44	PH8231044 CAP
45	PSB80M CAP SCREW M3-.5 X 8
46	PH8231046 SPECIAL NUT
47	PORS060 O-RING 59.5 X 2.0 S60
48	PORP004 O-RING 3.8 X 1.9 P4
49	PH8231049 DRIVER GUIDE
50	PH8231050 ADJUSTING KNOB
51	PH8231051 ADJUST BOLT
52	PH8231052 COMPRESSION SPRING
53	PH8231053 ADJUST BOLT
54	PSB31M CAP SCREW M8-1.25 X 25
55	PH8231055 PAWL
56	PH8231056 PAWL SPRING

REF PART #	DESCRIPTION
57	PH8231057 GROOVED CLEVIS PIN
58	PH8231058 RUBBER RETAINER
59	PORP010-A O-RING 9.8 X 2.4 P10A
60	PH8231060 PISTON
61	PORP021 O-RING 20.8 X 2.4 P21
62	PH8231062 SPRING
63	PH8231063 PISTON BUMPER WASHER
64	PH8231064 SPRING BASE
65	PH8231065 SNAP RETAINER
66	PH8231066 COVER BOARD
67	PH8231067 CONNECT POLE
68	PH8231068 COMPRESSION SPRING
69	PH8231069 PAWL
70	PH8231070 GROOVED CLEVIS PIN
71	PH8231071 COMPRESSION SPRING
72	PH8231072 SPECIAL PIN
73	PRP61M ROLL PIN 3 X 12
74	PH8231074 COMPRESSION SPRING
75	PH8231075 SAFETY STAND
76	PH8231076 MAGAZINE
77	PH8231077 MAGAZINE COVER
78	PH8231078 ANVIL
79	PH8231079 SPRING HOOK
80	PH8231080 ADJUST PLATE
81	PH8231081 ALUMINUM SLICE
82	PH8231082 ADJUST SLEEVE
83	PH8231083 NAIL DEPTH ADJUST BASE
84	PH8231084 RUBBER WASHER
85	PH8231085 SPRING
86	PSB07M CAP SCREW M6-1 X 30
87	PLN03M LOCK NUT M6-1
88	PSB29M CAP SCREW M6-1 X 40
89	PH8231089 FIXED RING
90	PH8231090 NAILS HEAD COVER
91	PH8231091 PROTECTIVE FILM
92	PW03M FLAT WASHER 6MM
93	PH8231093 FIXED RUBBER WASHER
94	PH8231094 GRIP
95	PH8231095 END PLATE WASHER
96	PH8231096 END PLATE
97	PLW01M LOCK WASHER 5MM
98	PSB15M CAP SCREW M5-.8 X 20
99	PH8231099 AIR INLET PLUG
100	PH8231100 PLUG CAP
101	PH8231101 CARRYING CASE
102	PH8231102 SAFETY GLASSES
103	PAW06M HEX WRENCH 6MM
104	PAW05M HEX WRENCH 5MM
105	PAW04M HEX WRENCH 4MM
106	PAW03M HEX WRENCH 3MM
107	PH8231107 O-RING REPAIR KIT
108	PH8231108 PISTON REPAIR KIT
109	PH8231109 NAILER WARNING LABEL
110	PH8231110 GRIZZLY LOGO LABEL
111	PH8231111 MACHINE ID LABEL

WARRANTY AND RETURNS

Grizzly Industrial, Inc. warrants every product it sells for a period of **1 year** to the original purchaser from the date of purchase. This warranty does not apply to defects due directly or indirectly to misuse, abuse, negligence, accidents, repairs or alterations or lack of maintenance. This is Grizzly's sole written warranty and any and all warranties that may be implied by law, including any merchantability or fitness, for any particular purpose, are hereby limited to the duration of this written warranty. We do not warrant or represent that the merchandise complies with the provisions of any law or acts unless the manufacturer so warrants. In no event shall Grizzly's liability under this warranty exceed the purchase price paid for the product and any legal actions brought against Grizzly shall be tried in the State of Washington, County of Whatcom.

We shall in no event be liable for death, injuries to persons or property or for incidental, contingent, special, or consequential damages arising from the use of our products.

To take advantage of this warranty, contact us by mail or phone and give us all the details. We will then issue you a "Return Authorization Number," which must be clearly posted on the outside as well as the inside of the carton. We will not accept any item back without this number. Proof of purchase must accompany the merchandise.

The manufacturers reserve the right to change specifications at any time because they constantly strive to achieve better quality equipment. We make every effort to ensure that our products meet high quality and durability standards and we hope you never need to use this warranty.

Please feel free to write or call us if you have any questions about the machine or the manual.

Grizzly Industrial, Inc.
1203 Lycoming Mall Circle
Muncy, PA 17756
Phone: (570) 546-9663
Fax: (800) 438-5901

E-Mail:
techsupport@grizzly.com

Web Site: <http://www.grizzly.com>

Thank you again for your business and continued support. We hope to serve you again soon!