

Grizzly *Industrial, Inc.*®

MINI HVLP SPRAY GUN W/GAUGE

MODEL H7670

INSTRUCTION MANUAL



COPYRIGHT © JULY, 2005 BY GRIZZLY INDUSTRIAL, INC., REVISED JULY, 2011 (TS)
WARNING: NO PORTION OF THIS MANUAL MAY BE REPRODUCED IN ANY SHAPE
OR FORM WITHOUT THE WRITTEN APPROVAL OF GRIZZLY INDUSTRIAL, INC.

#PC7361 PRINTED IN CHINA



WARNING!

Some dust created by power sanding, sawing, grinding, drilling, and other construction activities contains chemicals known to the State of California to cause cancer, birth defects or other reproductive harm. Some examples of these chemical are:

- **Lead from lead-based paints.**
- **Crystalline silica from bricks, cement and other masonry products.**
- **Arsenic and chromium from chemically-treated lumber.**

Your risk from these exposures varies, depending on how often you do this type of work. To reduce your exposure to these chemicals: Work in a well ventilated area, and work with approved safety equipment, such as those dust masks that are specially designed to filter out microscopic particles.

Table of Contents

SECTION 1: SAFETY	4
Additional Safety Instructions for HVLP Spray Guns	6
SECTION 2: INTRODUCTION	7
Foreword	7
Tool Data	7
Contact Info	7
SECTION 3: SET UP	8
Unpacking	8
Inventory	8
Assembly	9
Controls	9
SECTION 4: OPERATIONS	10
Spraying	10
Atomizing Cap and Fan Adjustments	12
SECTION 5: MAINTENANCE	13
Cleaning	13
Lubrication	14
Troubleshooting	15
Parts Breakdown	17
WARRANTY AND RETURNS	18

SECTION 1: SAFETY

WARNING

For Your Own Safety Read Instruction Manual Before Operating This Equipment

The purpose of safety symbols is to attract your attention to possible hazardous conditions. This manual uses a series of symbols and signal words which are intended to convey the level of importance of the safety messages. The progression of symbols is described below. Remember that safety messages by themselves do not eliminate danger and are not a substitute for proper accident prevention measures.

DANGER

Indicates an imminently hazardous situation which, if not avoided, WILL result in death or serious injury.

WARNING

Indicates a potentially hazardous situation which, if not avoided, COULD result in death or serious injury.

CAUTION

Indicates a potentially hazardous situation which, if not avoided, MAY result in minor or moderate injury. It may also be used to alert against unsafe practices.

NOTICE

This symbol is used to alert the user to useful information about proper operation of the equipment.

WARNING

Safety Instructions For Pneumatic Tools

- KEEP ALL SAFETY DEVICES IN PLACE** and in working order.
- REMOVE ADJUSTING KEYS AND WRENCHES.** Form habit of checking to see that keys and adjusting wrenches are removed from tool before operation.
- KEEP WORK AREA CLEAN.** Cluttered areas and benches invite accidents.
- DO NOT USE IN DANGEROUS ENVIRONMENT.** Do not use pneumatic tools in damp or wet locations, or where any flammable or noxious fumes may exist. Keep work area well lighted.
- KEEP CHILDREN AND VISITORS AWAY.** All children and visitors should be kept at a safe distance from work area.
- MAKE WORKSHOP CHILD PROOF** by locking your shop and shutting off air valves.
- DO NOT FORCE TOOL.** It will do the job better and safer at the rate for which it was designed.
- USE THE RIGHT TOOL.** Do not force tool or attachment to do a job for which it was not designed.
- DO NOT USE UNDER THE INFLUENCE OF DRUGS OR ALCOHOL.**

WARNING

Safety Instructions For Pneumatic Tools

10. **USE PROPER AIR HOSE** for the tool. Make sure your air hose is in good condition and is long enough to reach your work without stretching.
11. **WEAR PROPER APPAREL.** Do not wear loose clothing, gloves, neckties, rings, bracelets, or other jewelry which may get caught in moving parts. Non-slip footwear is recommended. Wear a protective hair covering to contain long hair.
12. **ALWAYS USE SAFETY GLASSES.** Also use a face or dust mask if cutting operation is dusty. Everyday eyeglasses only have impact resistant lenses, they are NOT safety glasses.
13. **WEAR APPROVED HEARING PROTECTION.**
14. **SECURE WORK.** Use clamps or a vise to hold work when practical. It is safer than using your hand and frees both hands to operate tool.
15. **DO NOT OVERREACH.** Keep proper footing and balance at all times.
16. **MAINTAIN TOOLS WITH CARE.** Keep tools lubricated and clean for best and safest performance. Follow instructions for lubricating and changing accessories.
17. **REDUCE THE RISK OF UNINTENTIONAL STARTING.** Do not carry tool with hand on trigger and always disconnect from air when not in use.
18. **DISCONNECT TOOLS** before servicing and changing accessories.
19. **USE THE RECOMMENDED ACCESSORIES.** Consult the owner's manual for recommended accessories. The use of improper accessories may cause risk of injury.
20. **CHECK DAMAGED PARTS.** Before further use of the tool, a guard or other part that is damaged should be carefully checked to determine that it will operate properly and perform its intended function. Check for alignment of moving parts, binding of moving parts, breakage of parts, mounting, and any other conditions that may affect its operation. A guard or other part that is damaged should be properly repaired or replaced.
21. **NEVER LEAVE UNATTENDED TOOL CONNECTED TO AIR.** Disconnect the air hose and do not leave tool until it is relieved of any built up pressure.
22. **NEVER ALLOW UNTRAINED USERS TO USE THIS TOOL WHILE UNSUPERVISED.**
23. **IF YOU ARE UNSURE OF THE INTENDED OPERATION, STOP USING THE TOOL.** Seek formal training or research books or magazines that specialize in pneumatic tools.

WARNING

Additional Safety Instructions for HVLP Spray Guns

1. **READ THIS MANUAL.** This manual contains proper operating instructions for this spray gun.
2. **READ MATERIAL LABELS and MATERIAL SAFETY DATA SHEETS (MSDS).** Read and know all the instructions on the packaging label and the MSDS before opening the package. This information could save your life.
3. **ALWAYS WEAR A NIOSH APPROVED RESPIRATOR WHEN SPRAYING OR WORKING AROUND FINISHING MATERIALS.**
4. **FIRE EXTINGUISHERS.** Always have a fully charged multi class or class B fire extinguisher in the immediate area.
5. **FLAMMABLE MATERIAL.** NEVER spray near open flame or where any spark could occur.
6. **FRESH AIR.** Always provide adequate exhaust to keep area free of built up vapors, NEVER spray in an enclosed space.
7. **DISCONNECT COMPRESSED AIR.** Always disconnect the spray gun from compressed air before cleaning, changing attachments or when performing maintenance of any kind on this tool.
8. **PROTECTIVE CLOTHING.** Protect exposed skin from overspray by wearing a protective suit or other approved garment.
9. **INAPPROPRIATE USE.** DO NOT point or shoot spray gun directly at yourself or another person or animals. Do not attempt to use the spray gun for any other use than it was intended.
10. **STORAGE.** Thoroughly clean and dry spray gun before storage. Store in an approved cabinet.
11. **SOLVENTS.** Always store solvents and shop towels soaked in solvent in approved containers.
12. **EYE PROTECTION.** Wear eye protection whenever spraying or cleaning. Solvents and chemicals can cause serious eye injury, which could lead to blindness.
13. **OPERATING PRESSURE.** DO NOT exceed the recommended inlet air pressure. Excessive pressure could cause the spray gun to burst or cause other internal equipment damage.
14. **LOCAL LAWS.** Consult local authorities regarding exhaust and waste disposal requirements.

SECTION 3: SET UP

Unpacking

Your spray gun left our warehouse in a carefully packed box. If you discover the spray gun is damaged after you have signed for delivery, *please immediately call Customer Service at (570) 546-9663 for advice.*

Save the containers and all packing materials for possible inspection by the carrier or its agent. *Otherwise, filing a freight claim can be difficult.*

When you are completely satisfied with the condition of the shipment, you should inventory the equipment.

Inventory

After you have unpacked the carton you should find the following:

Model H7670 Inventory (Figure 1)

A. Spray Gun	1
B. Cup 100 ml	1
C. Cleaning Brush	1
D. Service Wrench.....	1
E. Filters	2
F. Barbed Hose Fitting.....	1
G. Lock Nut.....	1
H. Gauge	1

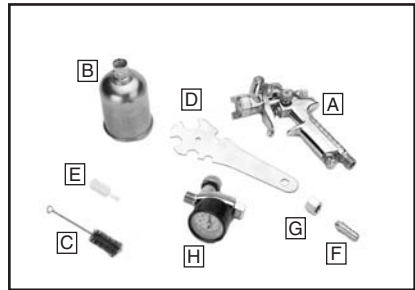

Figure 1. Model H7670 inventory.

Assembly

1. Insert the filter into the gun body (see **Figure 2**).



Figure 2. Installing filter.

2. Screw the cup onto the top of the body.
3. Install the barbed hose fitting into the base of the gun handle and tighten in place with the lock nut.
4. Secure the air hose to the barbed fitting with a hose clamp.

Note: Using a 1/4" NPS quick disconnect set-up (not included), will make operation and maintenance tasks easier.

5. Attach the spray gun to an air hose regulated between 43.5 and 58 PSI.

Note: For the best results, use a hose that will be dedicated for spray use only. Do not use a hose that has been used with an in-line oiler or other possible contaminant.

If you need additional help with this assembly, call our Technical Support at: (570) 546-9663.

Controls

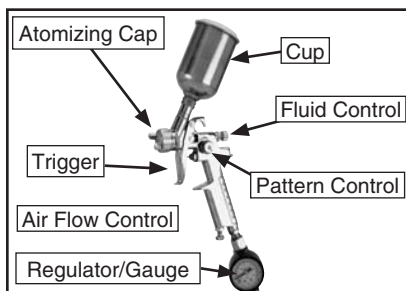

Figure 3. Controls.

1. **Fluid Control:** Controls the volume of material that travels through the fluid tip.
2. **Pattern Control:** Adjusts the spray pattern from a round pattern to a wide fan.
3. **Air Flow Control:** Controls the fluid pressure inside the spray gun.
4. **Atomizing Cap:** Controls the spray pattern from vertical to horizontal.
5. **Trigger:** Two stage trigger. Stage one only releases compressed air for blowing off the work piece. Stage two sprays material.
6. **Cup:** 100 ml metal cup allows for easy clean-up. Includes a vented cap.
7. **Regulator/Gauge:** Regulates inlet air pressure to the spray gun. It can be attached directly to the gun for on-the-spot air adjustments or directly from the air source.

Note: DO NOT attach to an unregulated air source that exceeds 120 PSI.

SECTION 4: OPERATIONS

! DANGER



EXPLOSION HAZARD! DO NOT smoke or have any source of flame or spark near spraying. Vapors will explode if ignited.

! WARNING



RESPIRATORY HAZARD! Always use respirator rated for organic vapor and solvent use when using spray equipment. Failure to protect your lungs can lead to respiratory illness and nervous system damage.

! WARNING



TOXIC FUMES! Always use an approved spray booth or well ventilated area when spraying. NEVER spray in a confined space where toxic fumes and flammable vapors can accumulate to deadly levels.

Spraying

The Model H7670 HVLP spray gun is designed to spray low to medium solid materials, like lacquers, stains, primers, multi-component paints, acrylics, epoxies etc. It is ideal for auto body touch-ups, woodworking projects, or projects with hard to reach areas. It is not for use with any waterborne material.

To use your spray gun:

1. Read and follow the material manufacturer's instructions for spraying, mixing, safety, disposal, and any other instruction on the label or Material Safety Data Sheet (MSDS).
2. Ensure the cup is securely tightened and all other fittings are secure to avoid air leaks or material spills.
3. Set the inlet air pressure (the air coming to the spray gun) to the lowest pressure recommended in **Tool Data** on **Page 7** or to the material manufacturer's recommendations.
4. Adjust the atomizing cap to vertical or horizontal. See **Atomizing Cap and Fan Adjustments** on **Page 12** for further explanation.
5. Fill the cup with material.
6. Trial and error are necessary to achieve the results you want along with a fair amount of practice. Test your material flow and spray pattern on a piece of cardboard or some scrap of material similar to your project.

7. Adjust the fluid control knob to start with a low volume of material and keep the atomization as low as possible. You will need to use a combination of fluid control, inlet air pressure, air flow control and stroke speed to achieve the results you want. Spray so the material wets out nicely without running or sagging.
8. Use the pattern control knob to adjust the spray fan to your desired pattern.
9. Keep the gun tip perpendicular, parallel and 6-8" from the work at all times when spraying as shown in **Figure 4**. Do not allow your wrist to bend. This will cause the gun to arc across the surface and distribute the material unevenly, possibly creating sags and dry spots.

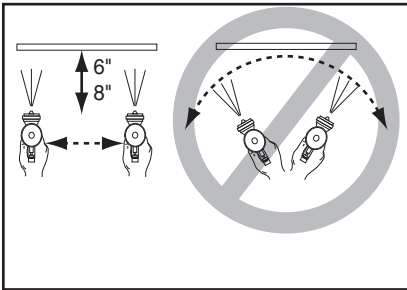

Figure 4. Spray technique.

NOTICE

Tipping spray gun may cause material to spill out of the cup. Always hold the spray gun perpendicular to the ground to avoid potential spills and gravity feed problems.

10. Begin spraying 2-3 inches before the work and continue to the end of the work. Continue the motion for a few inches past the work until you are ready for the return stroke.
11. Maintain an even speed when spraying.
12. Overlap each stroke by 50%. This will ensure even coverage as shown in **Figure 5**. Less than 50%, as shown in the figure to the right, may lead to missed spots or streaky results.

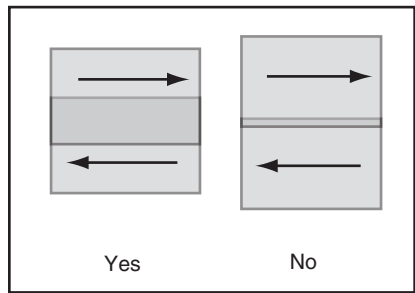

Figure 5. Overlap technique.

13. Spray stroke should have even consistency and parallel edges. If it doesn't, please refer to **Troubleshooting** on **Page 15**.

Atomizing Cap and Fan Adjustments

The atomizing cap needs to be adjusted for horizontal or vertical spraying patterns. Spraying in the wrong direction may lead to material build up on the atomizing cap horn. Many performance problems are caused by clogged atomizing holes on the atomizing cap horns (see **Cleaning** on **Page 13**).

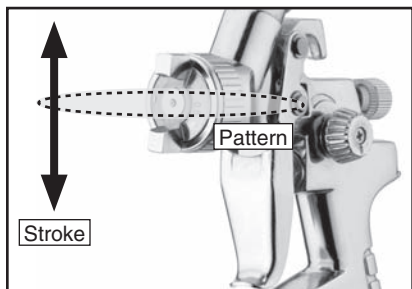

Figure 6. Set up for vertical stroke direction with horizontal fan pattern.

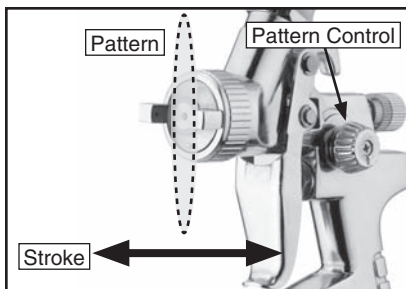

Figure 7. Set up for horizontal spray stroke with vertical fan pattern.

Rotating the pattern adjustment control in **Figure 7** will give you a range between the two patterns in **Figure 8**.

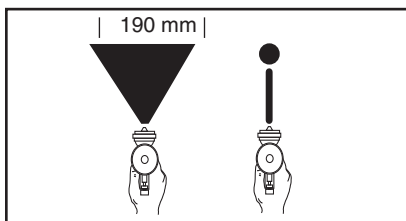

Figure 8. Fan adjustment.

SECTION 5: MAINTENANCE

Cleaning

Proper cleaning is the best way to ensure trouble free performance from your spray gun. If your gun is not thoroughly cleaned, damage and poor spraying will result. Problems caused by improper cleaning will not be covered by the warranty. Clean the spray gun immediately after each use.

To clean your spray gun:

1. Spray a small amount of solvent through the spray gun.

Note: Check with local laws regarding this practice. If you are spraying on a regular basis, spraying solvents into the air may be illegal. A cabinet style spray gun cleaner may be required.

2. **Disconnect the gun from the compressed air!**
3. Unscrew the cup.
4. Disassemble the gun by unscrewing the fluid control knob, removing the spring and needle.

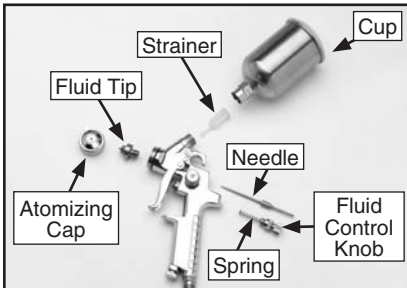

Figure 9. Disassembly for cleaning.

5. Unscrew the atomizing cap with your fingers and the fluid tip with the service wrench. The fully disassembled gun should look like **Figure 9**.
6. Rinse these parts thoroughly in solvent then dry with compressed air or let air dry.

Note: If the small holes in the atomizing cap become blocked, soak in clean solvent. If the blockage still exists, clear the blockage with a small needle, taking great care to not enlarge or damage the hole. Damage to the hole will create a disrupted spray pattern.

7. Use the cleaning brush with solvent to clean the inner orifice and other hard to reach areas on the outside of the spray gun body.
8. Wipe the rest of the gun body with a shop towel and dry.

⚠ WARNING

EXPLOSION HAZARD! Chlorinated Solvents like Trichloroethane and Methylene Chloride (methyl chloride) can chemically react with aluminum and may explode. Many parts in spray guns are made of aluminum. Read solvent label carefully before using solvent.

NOTICE

DO NOT soak the spray gun body in solvent. Prolonged exposure to solvent will rapidly deteriorate the spray gun washers and seals. Ignoring this notice will void your warranty.

Lubrication

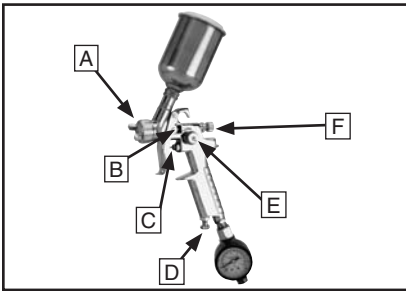







Figure 10. Lubrication points.

Lubricate the following areas with spray gun lube after cleaning.

- A. Atomizing Cap Threads
- B. Air Valve Packing
- C. Trigger Pin
- D. Air Flow Control Valve
- E. Pattern Control
- F. Fluid Control Knob

After each cleaning apply a thin film of petroleum jelly to the needle spring before reassembling.

Troubleshooting

Symptom	Possible Cause	Solution
Fluttering or Spitting spray. 	<ol style="list-style-type: none"> 1. Dry or worn fluid tip seat permits air to seep into fluid passage. 2. Material level too low. 3. Fluid tip or strainer obstructed. 4. Dry needle packing. 	<ol style="list-style-type: none"> 1. Tighten fluid tip or replace seat with new one. 2. Add material. 3. Clean 4. Lubricate needle.
Uneven top or bottom pattern. 	<ol style="list-style-type: none"> 1. Atomizing cap holes are obstructed. 2. Build-up on top or bottom of fluid tip. 3. Build-up on atomizing cap is on needle seat. 	<ol style="list-style-type: none"> 1. Clear holes. 2. Clean. 3. Clean.
Right or left arc pattern. 	<ol style="list-style-type: none"> 1. Left or right side horn holes are plugged. 2. Build-up on left or right side of fluid tip. 3. Build-up of material inside atomizing cap. 	<ol style="list-style-type: none"> 1. Clear holes. 2. Clean. 3. Clean.
Heavy deposit of material in center. 	<ol style="list-style-type: none"> 1. The material flow exceeds the atomizing cap capacity. 2. Inlet air pressure is too low. 3. Material is too thick. 	<ol style="list-style-type: none"> 1. Lower fluid flow. 2. Increase inlet air pressure. 3. Thin material.
Narrow center pattern. 	<ol style="list-style-type: none"> 1. Volume control turned in too far. 2. Inlet air pressure too high. 3. Fluid pressure is too low. 4. Material is too thin. 	<ol style="list-style-type: none"> 1. Increase volume. 2. Reduce inlet air pressure. 3. Increase fluid pressure. 4. Adjust material.
No spray output.	<ol style="list-style-type: none"> 1. No pressure at gun. 2. Fluid passages dirty. 3. Fluid control closed. 4. Out of paint. 	<ol style="list-style-type: none"> 1. Check air supply. 2. Clean gun, remove any obstructions. 3. Open. 4. Refill.
Nailer does not fire.	<ol style="list-style-type: none"> 1. Nail is jammed in magazine or discharge area. 2. Piston shaft is damaged. 3. Air pressure too low. 	<ol style="list-style-type: none"> 1. Clear nailer magazine or discharge area. 2. Replace piston shaft. 3. Check/increase air pressure.

Symptom	Possible Cause	Solution
Excessive over-spray.	<ol style="list-style-type: none"> 1. Fluid pressure too high. 2. Gun is too far from surface. 3. Spraying too fast. 	<ol style="list-style-type: none"> 1. Reduce fluid pressure. 2. Keep gun at recommended distance. 3. Slow down and maintain consistent, even parallel stroke.
Unable to control spray fan.	<ol style="list-style-type: none"> 1. Pattern adjustment screw is not seating properly. 2. Atomizing cap is loose. 	<ol style="list-style-type: none"> 1. Clean or replace. 2. Tighten atomizing cap.
Runs and sags.	<ol style="list-style-type: none"> 1. Damaged seal. 	<ol style="list-style-type: none"> 1. Replace damaged seals.
Material leaks from cup.	<ol style="list-style-type: none"> 1. Cap not secure. 2. Cup not tight on gun body. 3. Leaking from cap vent hole. 	<ol style="list-style-type: none"> 1. Tighten. 2. Tighten. 3. Hold gun upright do not tilt.
Material leaks from gun.	<ol style="list-style-type: none"> 1. Fluid tip loose. 2. Dry or damaged seals. 3. Excessive pressure. 	<ol style="list-style-type: none"> 1. Tighten. 2. Replace seals. 3. Reduce pressure.
Thick dimpled finish aka "Orange Peel."	<ol style="list-style-type: none"> 1. Holding gun too close to surface. 2. Inlet air pressure too low. 3. Material not properly mixed. 4. Surface is dirty or oily. 	<ol style="list-style-type: none"> 1. Spray at recommended distance. 2. Check inlet air pressure. 3. Follow manufacturer's instructions. 4. More surface prep is required.
Dry Spray.	<ol style="list-style-type: none"> 1. Inlet air pressure too high. 2. Gun too far from surface. 3. Gun stroke too fast. 	<ol style="list-style-type: none"> 1. Lower inlet air pressure. 2. Keep gun at recommended distance. 3. Slow down and maintain consistent even parallel stroke.
Gun leaks from fluid tip.	<ol style="list-style-type: none"> 1. Debris will not let the needle seat with the fluid tip. 	<ol style="list-style-type: none"> 1. Clean or replace both.
Contaminated paint.	<ol style="list-style-type: none"> 1. Water or oil in the air line. 	<ol style="list-style-type: none"> 1. Install an in-line air filter. 2. Replace air line.

Parts Breakdown

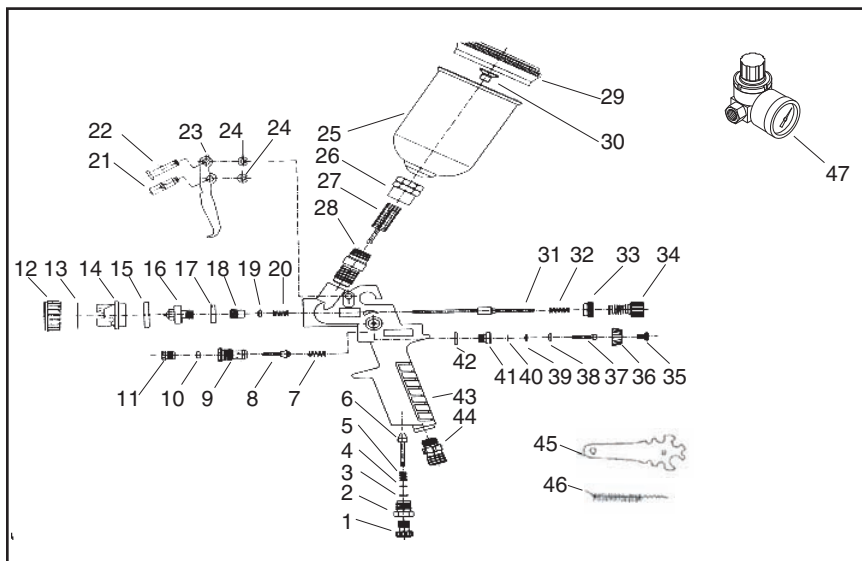

REF	PART #	DESCRIPTION	REF	PART #	DESCRIPTION
1	PH7670001	AIR ADJUSTABLE SCREW	25	PH7670025	CONTAINER
2	PH7670002	AIR ADJUSTABLE KNOB	26	PH7670026	JOINT NUT
3	PH7670003	O-RING	27	PH7670027	FILTER
4	PH7670004	DOMED SEAL WASHER	28	PH7670028	FLUID INLET JOINT
5	PH7670005	AIR ADJUSTABLE SPRING	29	PH7670029	CONTAINER COVER
6	PH7670006	AIR INLET VALVE	30	PH7670030	SMALL JOINT NUT
7	PH7670007	SWITCH SPRING	31	PH7670031	FLUID NEEDLE
8	PH7670008	AIR INLET VALVE ASS'Y	32	PH7670032	FLUID NEEDLE SPRING
9	PH7670009	SWITCH KNOB	33	PH7670033	JOINT CAP
10	PH7670010	SWITCH WASHER	34	PH7670034	FLUID ADJUSTABLE KNOB
11	PH7670011	LOCK SCREW	35	PH7670035	PHILLIPS SCREW
12	PH7670012	NUT	36	PH7670036	PATTERN ADJ JOINT CAP
13	PH7670013	AIR CAP WASHER	37	PH7670037	PATTERN ADJ SCREW
14	PH7670014	ATOMIZATION	38	PH7670038	O-RING
15	PH7670015	NUT HOUSING	39	PH7670039	O-RING
16	PH7670016	FLUID NOZZLE	40	PH7670040	E-CLIP
17	PH7670017	FLUID NOZZLE WASHER	41	PH7670041	PATTERN ADJ KNOB
18	PH7670018	DIRECTION SCREW	42	PH7670042	O-RING
19	PH7670019	ADJ NEEDLE WASHER	43	PH7670043	GUN BODY
20	PH7670020	COMPRESSED SPRING	44	PH7670044	AIR INLET JOINT
21	PH7670021	TRIGGER PIN I	45	PH7670045	SERVICE WRENCH
22	PH7670022	TRIGGER PIN II	46	PH7670046	CLEANING BRUSH
23	PH7670023	TRIGGER	47	PH7670047	AIR REGULATOR
24	PH7670024	SNAP RETAINER			

WARRANTY AND RETURNS

Grizzly Industrial, Inc. warrants every product it sells for a period of **1 year** to the original purchaser from the date of purchase. This warranty does not apply to defects due directly or indirectly to misuse, abuse, negligence, accidents, repairs or alterations or lack of maintenance. This is Grizzly's sole written warranty and any and all warranties that may be implied by law, including any merchantability or fitness, for any particular purpose, are hereby limited to the duration of this written warranty. We do not warrant or represent that the merchandise complies with the provisions of any law or acts unless the manufacturer so warrants. In no event shall Grizzly's liability under this warranty exceed the purchase price paid for the product and any legal actions brought against Grizzly shall be tried in the State of Washington, County of Whatcom.

We shall in no event be liable for death, injuries to persons or property or for incidental, contingent, special, or consequential damages arising from the use of our products.

To take advantage of this warranty, contact us by mail or phone and give us all the details. We will then issue you a "Return Authorization Number," which must be clearly posted on the outside as well as the inside of the carton. We will not accept any item back without this number. Proof of purchase must accompany the merchandise.

The manufacturers reserve the right to change specifications at any time because they constantly strive to achieve better quality equipment. We make every effort to ensure that our products meet high quality and durability standards and we hope you never need to use this warranty.

Please feel free to write or call us if you have any questions about the machine or the manual.

Grizzly Industrial, Inc.
1203 Lycoming Mall Circle
Muncy, PA 17756
Phone: (570) 546-9663
Fax: (800) 438-5901

E-Mail:
techsupport@grizzly.com

Web Site: <http://www.grizzly.com>

Thank you again for your business and continued support. We hope to serve you again soon!



WARRANTY CARD

Name _____

Street _____

City _____ State _____ Zip _____

Phone # _____ Email _____ Invoice # _____

Model # _____ Order # _____ Serial # _____

*The following information is given on a voluntary basis. It will be used for marketing purposes to help us develop better products and services. **All information is strictly confidential.***

1. How did you learn about us?

Advertisement Friend Catalog
 Card Deck Website Other: _____

2. Which of the following magazines do you subscribe to?

Cabinet Maker Popular Mechanics Today's Homeowner
 Family Handyman Popular Science Wood
 Hand Loader Popular Woodworking Wooden Boat
 Handy Practical Homeowner Woodshop News
 Home Shop Machinist Precision Shooter Woodsmith
 Journal of Light Cont. Projects in Metal Woodwork
 Live Steam RC Modeler Woodworker West
 Model Airplane News Rifle Woodworker's Journal
 Modeltec Shop Notes Other:
 Old House Journal Shotgun News

3. What is your annual household income?

\$20,000-\$29,000 \$30,000-\$39,000 \$40,000-\$49,000
 \$50,000-\$59,000 \$60,000-\$69,000 \$70,000+

4. What is your age group?

20-29 30-39 40-49
 50-59 60-69 70+

5. How long have you been a woodworker/metalworker?

0-2 Years 2-8 Years 8-20 Years 20+ Years

6. How many of your machines or tools are Grizzly?

0-2 3-5 6-9 10+

7. Do you think your machine represents a good value? Yes No

8. Would you recommend Grizzly Industrial to a friend? Yes No

9. Would you allow us to use your name as a reference for our customers in your area?

Note: *We never use names more than 3 times.* Yes No

10. Comments: _____

Send a Grizzly Catalog to a friend:

Name _____
Street _____
City _____ State _____ Zip _____

FOLD ALONG DOTTED LINE

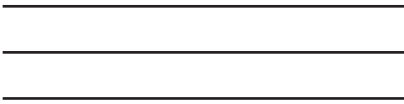

Place
Stamp
Here



GRIZZLY INDUSTRIAL, INC.
P.O. BOX 2069
BELLINGHAM, WA 98227-2069



TAPE ALONG EDGES--PLEASE DO NOT STAPLE