

Grizzly *Industrial, Inc.*®

MODEL G8993 4" TILE SAW OWNER'S MANUAL



COPYRIGHT © JULY, 2007 BY GRIZZLY INDUSTRIAL, INC.
WARNING: NO PORTION OF THIS MANUAL MAY BE REPRODUCED IN ANY SHAPE
OR FORM WITHOUT THE WRITTEN APPROVAL OF GRIZZLY INDUSTRIAL, INC.
#LO9296 PRINTED IN CHINA

 **WARNING!**

This manual provides critical safety instructions on the proper setup, operation, maintenance and service of this machine/equipment.

Failure to read, understand and follow the instructions given in this manual may result in serious personal injury, including amputation, electrocution or death.

The owner of this machine/equipment is solely responsible for its safe use. This responsibility includes but is not limited to proper installation in a safe environment, personnel training and usage authorization, proper inspection and maintenance, manual availability and comprehension, application of safety devices, blade/cutter integrity, and the usage of personal protective equipment.

The manufacturer will not be held liable for injury or property damage from negligence, improper training, machine modifications or misuse.

 **WARNING!**

Some dust created by power sanding, sawing, grinding, drilling, and other construction activities contains chemicals known to the State of California to cause cancer, birth defects or other reproductive harm. Some examples of these chemicals are:

- **Lead from lead-based paints.**
- **Crystalline silica from bricks, cement and other masonry products.**
- **Arsenic and chromium from chemically-treated lumber.**

Your risk from these exposures varies, depending on how often you do this type of work. To reduce your exposure to these chemicals: Work in a well ventilated area, and work with approved safety equipment, such as those dust masks that are specially designed to filter out microscopic particles.

SECTION 1: SAFETY

WARNING

For Your Own Safety Read Instruction Manual Before Operating This Equipment

The purpose of safety symbols is to attract your attention to possible hazardous conditions. This manual uses a series of symbols and signal words which are intended to convey the level of importance of the safety messages. The progression of symbols is described below. Remember that safety messages by themselves do not eliminate danger and are not a substitute for proper accident prevention measures.

DANGER

Indicates an imminently hazardous situation which, if not avoided, WILL result in death or serious injury.

WARNING

Indicates a potentially hazardous situation which, if not avoided, COULD result in death or serious injury.

CAUTION

Indicates a potentially hazardous situation which, if not avoided, MAY result in minor or moderate injury. It may also be used to alert against unsafe practices.

NOTICE

This symbol is used to alert the user to useful information about proper operation of the equipment.

WARNING

Safety Instructions for Machinery

- 1. READ THROUGH THE ENTIRE MANUAL BEFORE STARTING MACHINERY.** Machinery presents serious injury hazards to untrained users.
- 2. ALWAYS USE ANSI APPROVED SAFETY GLASSES WHEN OPERATING MACHINERY.** Everyday eyeglasses only have impact resistant lenses, they are NOT safety glasses.
- 3. ALWAYS WEAR A NIOSH APPROVED RESPIRATOR WHEN OPERATING MACHINERY THAT PRODUCES DUST.** Wood dust is a carcinogen and can cause cancer and severe respiratory illnesses.
- 4. ALWAYS USE HEARING PROTECTION WHEN OPERATING MACHINERY.** Machinery noise can cause permanent hearing damage.
- 5. WEAR PROPER APPAREL.** DO NOT wear loose clothing, gloves, neckties, rings, or jewelry which may get caught in moving parts. Wear protective hair covering to contain long hair and wear non-slip footwear.
- 6. NEVER OPERATE MACHINERY WHEN TIRED, OR UNDER THE INFLUENCE OF DRUGS OR ALCOHOL.** Be mentally alert at all times when running machinery.

7. **ONLY ALLOW TRAINED AND PROPERLY SUPERVISED PERSONNEL TO OPERATE MACHINERY.** Make sure operation instructions are safe and clearly understood.
8. **KEEP CHILDREN AND VISITORS AWAY.** Keep all children and visitors a safe distance from the work area.
9. **MAKE WORKSHOP CHILD PROOF.** Use padlocks, master switches, and remove switch keys.
10. **NEVER LEAVE WHEN MACHINE IS RUNNING.** Turn power **OFF** and allow all moving parts to come to a complete stop before leaving machine unattended.
11. **DO NOT USE IN DANGEROUS ENVIRONMENTS.** DO NOT use machinery in damp, wet locations, or where any flammable or noxious fumes may exist.
12. **KEEP WORK AREA CLEAN AND WELL LIT.** Clutter and dark shadows may cause accidents.
13. **USE A GROUNDED EXTENSION CORD RATED FOR THE MACHINE AMPERAGE.** Undersized cords overheat and lose power. Replace extension cords if they become damaged. DO NOT use extension cords for 220V machinery.
14. **ALWAYS DISCONNECT FROM POWER SOURCE BEFORE SERVICING MACHINERY.** Make sure switch is in OFF position before reconnecting.
15. **MAINTAIN MACHINERY WITH CARE.** Keep blades sharp and clean for best and safest performance. Follow instructions for lubricating and changing accessories.
16. **MAKE SURE GUARDS ARE IN PLACE AND WORK CORRECTLY BEFORE USING MACHINERY.**
17. **REMOVE ADJUSTING KEYS AND WRENCHES.** Make a habit of checking for keys and adjusting wrenches before turning machinery on.
18. **CHECK FOR DAMAGED PARTS BEFORE USING MACHINERY.** Check for binding and alignment of parts, broken parts, part mounting, loose bolts, and any other conditions that may affect machine operation. Repair or replace damaged parts.
19. **USE RECOMMENDED ACCESSORIES.** Refer to the instruction manual for recommended accessories. The use of improper accessories may cause risk of injury.
20. **DO NOT FORCE MACHINERY.** Work at the speed for which the machine or accessory was designed.
21. **SECURE WORKPIECE.** Use clamps or a vise to hold the workpiece when practical. A secured workpiece protects your hands and frees both hands to operate the machine.
22. **DO NOT OVERREACH.** Keep proper footing and balance at all times.
23. **MANY MACHINES WILL EJECT THE WORKPIECE TOWARD THE OPERATOR.** Know and avoid conditions that cause the workpiece to "kickback."
24. **ALWAYS LOCK MOBILE BASES (IF USED) BEFORE OPERATING MACHINERY.**
25. **BE AWARE THAT CERTAIN WOODS MAY CAUSE AN ALLERGIC REACTION** in people and animals, especially when exposed to fine dust. Make sure you know what type of wood dust you will be exposed to and always wear an approved respirator.

WARNING

Additional Safety Instructions for Tile Saws

- 1. KEEP HANDS DRY NEAR ELECTRICITY.** Do not touch electrical connections with wet hands.
- 2. ALL PLUG AND RECEPTACLES MUST BE OFF THE GROUND AND IN A DRY LOCATION.**
- 3. KEEP BLADE WELL LUBRICATED.** Ensure that the blade remains lubricated with water when cutting or scribing concrete, tile, or stone.
- 4. WEAR AN APPROVED RESPIRATOR.** Always wear a NIOSH approved particulate respirator to prevent silicosis when cutting or scribing.
- 5. DISCONNECT THE POWER CORD WHEN NOT IN USE.** Always disconnect the machine from the power source before cleaning, changing attachments or when performing maintenance of any kind on this tool.
- 6. DO NOT WEAR LOOSE CLOTHING WHILE OPERATING THIS MACHINE.** Tie back long hair.
- 7. KEEP HANDS CLEAR.** Do not place hands near, or in contact with, cutting surfaces during operation.
- 8. INSPECT THE TOOL REGULARLY.** Perform machine inspections and maintenance service promptly as required.
- 9. ATTEND TO YOUR MACHINE.** Never walk away and leave the machine running.
- 10. KEEP BLADES IN GOOD CONDITION.** Replace or sharpen blade as needed.
- 11. USE THE CORRECT BLADES.** Match the correct diamond blade to the material being cut.
- 12. INSTALL BLADES PROPERLY.** Check that the directional arrow on the saw blade points in a clockwise direction as viewed from the mounting side.
- 13. INSPECT BLADES REGULARLY.** Before mounting the blade, inspect the arbor, arbor nut, and flanges for damage, wear, or looseness. Replace any damaged or worn parts.
- 14. TEST RUN THE MACHINE.** Always test run the machine before starting any work.

SECTION 2: INTRODUCTION

Foreword

We are proud to offer the Grizzly Model G8993 4" Tile Saw. This model is part of a growing Grizzly family of fine power tools. When used according to the guidelines set forth in this manual, you can expect years of trouble-free, enjoyable operation and proof of Grizzly's commitment to customer satisfaction.

It is our pleasure to provide this manual with the Model G8993. It was written to encourage safety considerations and guide you through general operating procedures and maintenance.

The specifications, details, and photographs in this manual represent the Model G8993 as supplied when the manual was prepared. However, owing to Grizzly's policy of continuous improvement, changes may be made at any time with no obligation on the part of Grizzly.

CAUTION

No list of safety guidelines can be complete. Every shop environment is different. Always consider safety first, as it applies to your individual working conditions. Use this and other machinery with caution and respect. Failure to do so could result in serious personal injury, damage to equipment or poor work results.

Contact Info

If you have any comments regarding this manual, please contact us:

Grizzly Industrial, Inc.
C/O Technical Documentation Manager
P.O. Box 2069
Bellingham, WA 98227-2069
Email: manuals@grizzly.com

Most importantly, we stand behind our tools. If you have any service questions or parts requests, please call or write us at the location listed below.

Grizzly Industrial, Inc.
1203 Lycoming Mall Circle
Muncy, PA 17756
Phone: (570) 546-9663
Fax: (800) 438-5901
E-Mail: techsupport@grizzly.com
Web Site: <http://www.grizzly.com>

WARNING

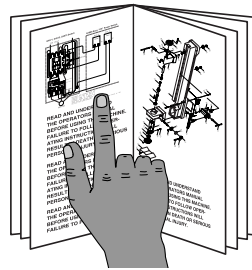

Read the manual before operation. Become familiar with this saw, its safety instructions, and its operation before beginning any work. Serious personal injury may result if safety or operational information is not understood or followed.

SECTION 3: SET UP

Unpacking

Your new item was carefully packaged for safe shipping. If you discover any damage after you have signed for delivery, *immediately call Customer Service at (570) 546-9663 for advice.*

Save the containers and all packing materials for possible inspection by the carrier or its agent. *Otherwise, filing a freight claim can be difficult.*

When you are completely satisfied with the condition of the shipment, you should inventory the contents.

WARNING



Always wear ANSI approved safety glasses, hearing protection, and an NIOSH approved respirator when operating this tile saw. Failure to follow this warning may result in severe injury or death.

Inventory

Model G8993 Inventory (Figure 1)

- A. Tile Saw
- B. Vinyl Hose.....
- C. Rubber Connector.....
- D. End Wrench (10mm, 19mm).....
- E. Box Wrench (10mm).....
- F. Water Valve
- G. Machine Screw (with washer).....

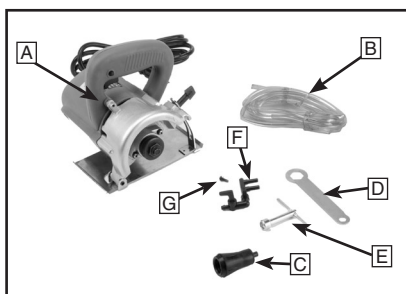

Figure 1. Model G8993 inventory.

Machine Data

Voltage	110V
Amps	8A
Motor Power	$\frac{3}{4}$ HP
Speed	11,000 RPM
Blade Size	4"
Arbor Size.....	$\frac{3}{4}$ "
Max Cutting Depth.....	34mm (1.34")
Weight (without cord).....	5.7 lbs

Assembly

1. Install appropriate blade (not included) using the box wrench and end wrench provided (**Figure 2**). The blade arbor retaining bolt has a reverse thread.



Figure 2. Attach the cutting blade.

2. Attach the water valve to the saw using the machine screw provided. The plug should be attached in such a manner that the watering posts sit on either side of the blade, and the valve sits near the back of the handle (**Figure 3**).

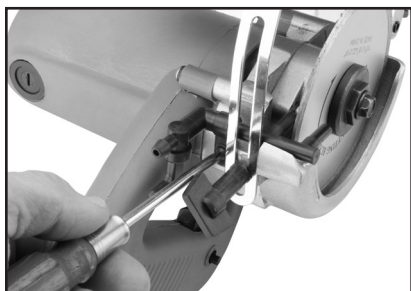

Figure 3. Attach the water plug.

3. Attach the vinyl hose to the water valve (**Figure 4**).



Figure 4. Attach the vinyl hose.

4. When connecting the tile saw to a threaded faucet or hose, use the supplied rubber connector. When using a water tank, the tank should be located at least 31½" higher than the work area (**Figure 5**).

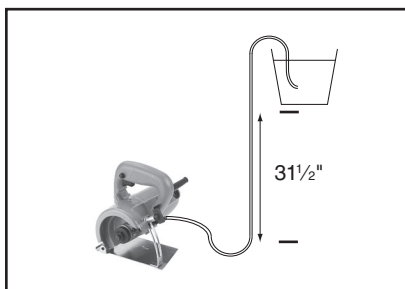

Figure 5. Using a water tank.

⚠ CAUTION

Serious personal injury could occur if you do not disconnect the saw from power while installing the blade or the watering attachment. Always unplug the saw while performing either of these actions.

SECTION 4: OPERATIONS

Operation

1. Put on safety goggles, hearing protection, and an approved respirator.
2. Set the saw base on the material to be cut. Use the side of the base to align the diamond wheel with the layout line.
3. Make sure the diamond wheel is kept off the material to be cut, and turn the switch **ON**.
4. Move the saw steadily along the layout line while maintaining a firm grip on the tool.
5. To adjust the cut depth, unplug the tool, then loosen the wing bolt on the base adjustment bracket and move the base to adjust the depth (**Figure 6**).
6. After adjusting the cutting depth, fasten the wing bolt securely.

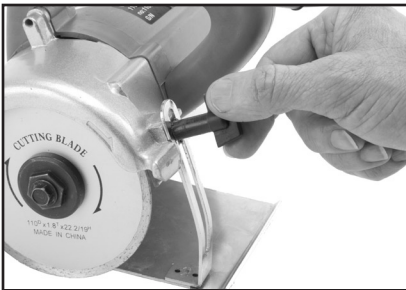

Figure 6. Adjusting the cutting depth.

! CAUTION

If the diamond wheel stops or makes an abnormal noise while operating, promptly switch the saw **OFF**.

! CAUTION

Shortened blade life and personal injury may result if the diamond wheel is not used properly. Do not use the diamond wheel for making curved or radius cuts.

! CAUTION

Always use the correct blade for the application. When cutting or scribing concrete, tile, or stone, always use the water attachment. Never use any blade other than a diamond blade with this saw.

NOTICE

If the cutting depth exceeds 20mm, as with concrete or other materials, the cut should be made with two passes; otherwise, blade and motor life may be shortened.

SECTION 6: MAINTENANCE

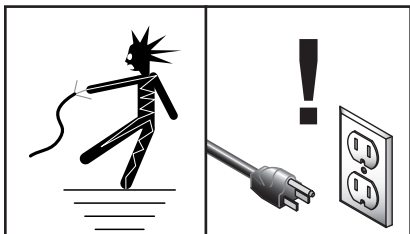

! WARNING

Always **DISCONNECT POWER** before servicing, adjusting, or doing maintenance to reduce the risk of accidental injury or electrocution.

Blade Replacement

1. **DISCONNECT THE SAW FROM POWER!**
2. Remove the arbor retaining bolt (reverse thread) and washers (**Figure 7**).



Figure 7. Replacing the diamond blade.

3. Thoroughly remove any dust accumulated on the spindle and washers.
4. Install the new blade with the concave portion of the washer contacting the blade.

5. Be sure that the arrows on the blade point in a clockwise direction, matching the arrow on the blade guard.
6. Securely fasten arbor retaining bolt.

Motor Brushes

1. **DISCONNECT THE SAW FROM POWER!**
2. To replace worn motor brushes, remove the brush caps, located on either side of the motor housing, with a screwdriver (**Figure 8**).



Figure 8. Removing a brush cap.

3. Install replacement brushes and fasten brush caps (**Figure 9**).



Figure 9. Replacing a motor brush.

Parts Breakdown

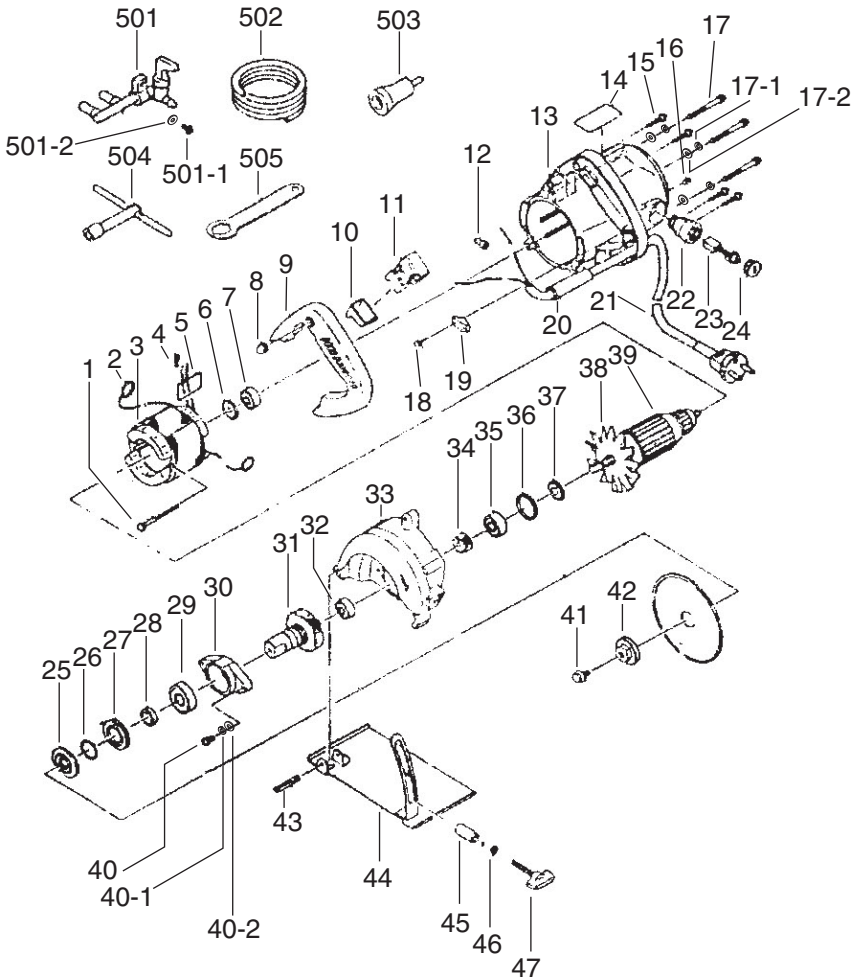

Parts List

REF	PART #	DESCRIPTION
1	PHTEK38M	TAP SCREW M4 X 60
2	P8993002	BRUSH TERMINAL
3	P8993003	STATOR ASSEMBLY
4	P8993004	TERMINAL
5	P8993005	SEAL PACKING
6	P8993006	BEARING WASHER
7	P608	BALL BEARING 608ZZ
8	P8993008	RUBBER COVER
9	P8993009	HANDLE COVER ASSEMBLY
10	P8993010	SWITCH RUBBER COVER
11	P8993011	SWITCH
12	P8993012	CONNECTOR
13	P8993013	HOUSING ASSEMBLY
14	P8993014	NAME PLATE
15	PHTEK31M	TAP SCREW M4 X 14
16	PSS31M	SET SCREW M5-.8 X 8
17	P8993017	SPECIAL SCREW M5-.8 X 30
17-1	PLW01M	LOCK WASHER 5MM
17-2	PW02M	FLAT WASHER 5MM
18	PHTEK31M	TAP SCREW M4 X 14
19	P8993019	CORD CLIP
20	P8993020	CORD ARMOR
21	P8993021	CORD
22	P8993022	BRUSH HOLDER
23	P8993023	CARBON BRUSH
24	P8993024	BRUSH CAP
25	P8993025	INSIDE BLADE FLANGE
26	P8993026	O-RING 15 X 6.5
27	P8993027	BEARING CAP
28	P8993028	SPACER
29	P6002	BALL BEARING 6002ZZ
30	P8993030	BEARING HOLDER
31	P8993031	SPINDLE GEAR
32	P606	BALL BEARING 606
33	P8993033	GEAR COVER
34	P8993034	PINION
35	P629	BALL BEARING 629ZZ
36	P8993036	RUBBER RING
37	P8993037	BEARING WASHER

REF	PART #	DESCRIPTION
38	P8993038	WOODRUFF KEY
39	P8993039	ARMATURE
40	P8993040	SPECIAL SCREW M5-.8 X 20
40-1	PLW01M	LOCK WASHER 5MM
40-2	PW02M	FLAT WASHER 5MM
41	P8993041	FLANGE BOLT M8-1.25 X 15 LH
42	P8993042	OUTSIDE BLADE FLANGE
43	PRP63M	ROLL PIN 6 X 34
44	P8993044	BASE
45	P8993045	SLEEVE
46	PLW03M	LOCK WASHER 6MM
47	P8993047	WING BOLT
501	P8993501	WATER PLUG
501-1	PS02M	PHLP HD SCR M4-.7 X 12
501-2	PW05M	FLAT WASHER 4MM
502	P8993502	VINYL HOSE
503	P8993503	ROBBER CONNECTOR
504	P8993504	T-WRENCH 10MM
505	P8993505	FLAT WRENCH 10/19MM

WARRANTY

Grizzly Industrial, Inc. warrants every product it sells for a period of **1 year** to the original purchaser from the date of purchase. This warranty does not apply to defects due directly or indirectly to misuse, abuse, negligence, accidents, repairs or alterations or lack of maintenance. This is Grizzly's sole written warranty and any and all warranties that may be implied by law, including any merchantability or fitness, for any particular purpose, are hereby limited to the duration of this written warranty. We do not warrant or represent that the merchandise complies with the provisions of any law or acts unless the manufacturer so warrants. In no event shall Grizzly's liability under this warranty exceed the purchase price paid for the product and any legal actions brought against Grizzly shall be tried in the State of Washington, County of Whatcom.

We shall in no event be liable for death, injuries to persons or property or for incidental, contingent, special, or consequential damages arising from the use of our products.

To take advantage of this warranty, contact us by mail or phone and give us all the details. We will then issue you a "Return Authorization Number," which must be clearly posted on the outside as well as the inside of the carton. We will not accept any item back without this number. Proof of purchase must accompany the merchandise.

The manufacturers reserve the right to change specifications at any time because they constantly strive to achieve better quality equipment. We make every effort to ensure that our products meet high quality and durability standards and we hope you never need to use this warranty.

Please feel free to write or call us if you have any questions about the machine or the manual.

Grizzly Industrial, Inc.
1203 Lycoming Mall Circle
Muncy, PA 17756
Phone: (570) 546-9663
Fax: (800) 438-5901

E-Mail:
techsupport@grizzly.com

Web Site: <http://www.grizzly.com>

Thank you again for your business and continued support. We hope to serve you again soon!



WARRANTY CARD

Name _____

Street _____

City _____ State _____ Zip _____

Phone # _____ Email _____ Invoice # _____

Model # _____ Order # _____ Serial # _____

*The following information is given on a voluntary basis. It will be used for marketing purposes to help us develop better products and services. **All information is strictly confidential.***

1. How did you learn about us?

Advertisement Friend Catalog
 Card Deck Website Other: _____

2. Which of the following magazines do you subscribe to?

Cabinet Maker Popular Mechanics Today's Homeowner
 Family Handyman Popular Science Wood
 Hand Loader Popular Woodworking Wooden Boat
 Handy Practical Homeowner Woodshop News
 Home Shop Machinist Precision Shooter Woodsmith
 Journal of Light Cont. Projects in Metal Woodwork
 Live Steam RC Modeler Woodworker West
 Model Airplane News Rifle Woodworker's Journal
 Modeltec Shop Notes Other:
 Old House Journal Shotgun News

3. What is your annual household income?

\$20,000-\$29,000 \$30,000-\$39,000 \$40,000-\$49,000
 \$50,000-\$59,000 \$60,000-\$69,000 \$70,000+

4. What is your age group?

20-29 30-39 40-49
 50-59 60-69 70+

5. How long have you been a woodworker/metalworker?

0-2 Years 2-8 Years 8-20 Years 20+ Years

6. How many of your machines or tools are Grizzly?

0-2 3-5 6-9 10+

7. Do you think your machine represents a good value? Yes No

8. Would you recommend Grizzly Industrial to a friend? Yes No

9. Would you allow us to use your name as a reference for our customers in your area?

Note: *We never use names more than 3 times.* Yes No

10. Comments: _____

Send a Grizzly Catalog to a friend:

Name _____
Street _____
City _____ State _____ Zip _____

FOLD ALONG DOTTED LINE



Place
Stamp
Here



GRIZZLY INDUSTRIAL, INC.
P.O. BOX 2069
BELLINGHAM, WA 98227-2069



TAPE ALONG EDGES--PLEASE DO NOT STAPLE